

Electricity use in the commercial kitchen

S. Mudie^{1*}, E.A. Essah², A. Grandison³ and R. Felgate⁴

¹*Technologies for Sustainable Built Environments (TSBE), University of Reading, JJ Thompson Building, Whiteknights, PO Box 220, Reading, Berkshire RG6 6AF, UK*

²*School of Construction Management and Engineering, University of Reading, Whiteknights, PO Box 220, Reading, Berkshire RG6 6AF, UK*

³*School of Food and Nutritional Sciences, University of Reading, Whiteknights, PO Box 220, Reading, Berkshire RG6 6AF, UK;* ⁴*Mitchells & Butlers plc., 27 Fleet Street, Birmingham B3 1JP, UK*

Abstract

Academic and industrial literature concerning the energy use of commercial kitchens is scarce. Electricity consumption data were collected from distribution board current transformers in a sample of fourteen UK public house-restaurants. This was set up to identify patterns of appliance use as well as to assess the total energy consumption of these establishments. The electricity consumption in the selected commercial kitchens was significantly higher than current literature estimates. On average, 63% of the premises' electricity consumption was attributed to the catering activity. Key appliances that contributed to the samples' average daily electricity consumption of the kitchen were identified as refrigeration (70 kWh, 41%), fryers (11 kWh, 13%), combination ovens (35 kWh, 12%), bain maries (27 kWh, 9%) and grills (37 kWh, 12%). Behavioural factors and poor maintenance were identified as major contributors to excessive electricity usage with potential savings of 70 and 45%, respectively. Initiatives are required to influence operator behaviour, such as the expansion of mandatory energy labelling, improved feedback information and the use of behaviour change campaigns. Strict maintenance protocols and more appropriate sizing of refrigeration would be of great benefit to energy reduction.

Keywords: electricity use; commercial kitchen; public house; energy conservation

*Corresponding author.
s.mudie@pgr.reading.ac.uk

Received 1 May 2013; revised 26 July 2013; accepted 21 August 2013

1 INTRODUCTION

The UK is committed to an 80% reduction in greenhouse gas emissions by 2050, compared with the levels in 1990 [1]. Catering businesses feature in virtually every town and city in the world and are vital buildings to be considered in any low-carbon plan. Commercial kitchens are some of the most profligate users of gas, water and electricity in the UK. As a result, they can leave a large carbon footprint, with relevant benchmarks (in kWh/m²) exceeding ten times the energy benchmarks of the majority of commercial premises (i.e. offices, retail premises, etc.) [2, 3].

The UK Carbon Trust and the Chartered Institute for Building Services (CIBSE) estimate that the total energy use of Britain's catering industry is in excess of 21 600 million kWh per year. CIBSE and the UK Carbon Trust estimate that 50% of this originates from non-commercial catering operations (hospitals, ministry of defence, schools, etc.), ~20% is attributed to hotel

and guest house kitchens and the remaining 30% originating from the activities of commercial kitchens (restaurants, public houses, cafes, etc.) [4, 5]. However, these estimations are drawn from energy use data from the USA. A recent study concerning the whole-premises electricity use of 772 pub-restaurants in the UK indicates that consumption is more than double the previous sector estimates by CIBSE and the Carbon Trust [3].

Despite their high energy usage [2, 3], very little industrial or academic research exists pertaining to the current consumption and energy reduction strategies of commercial kitchens [6]. There has been substantial research relating to energy use and reduction in the building fabric and envelope, which may be applied to these premises. However, beyond the procurement of more energy efficient cooking appliances, very little innovation has been achieved from catering operations. Indeed, the designs of cooking technologies have remained virtually stagnant since their creation [7].

Hot and cold meals are being prepared increasingly in public houses in response to the increasing number of ‘off licenses’ and shops selling alcohol and the duty levied on alcohol sales [8–10]. This has resulted in very few practical differences in the operation, licensing and management between restaurants and public houses (‘pubs’) in the UK, giving rise to the colloquial phrase ‘gastro-pub’.

There are many avenues of energy reduction in buildings (such as LED lighting, effective insulation, etc.), which are being pursued in the sector. However, the reduction of energy use from food preparation and cooking is seen as the largest challenge for catering establishments if they are to meaningfully reduce consumption in line with national and international targets [1]. In order to fill the vast gap in published knowledge concerning commercial kitchen energy use, the objectives of this study are to provide a comprehensive analysis of the electricity use in commercial catering establishments with a specific focus on food preparation and cooking activity. To achieve this, consumption patterns of key appliances in commercial premises are explored, and preliminary energy reduction strategies are suggested.

2 MATERIALS AND METHODS

2.1 Description of the sample

Fourteen sites in England were selected to take part in this study. The relatively small sample size reflects the practical and financial constraints of extensive monitoring of such appliances; the type of intensive analysis makes it difficult to target a large sample size [11], e.g. 400 individual appliances were monitored in this study.

Each site belongs to a large chain of UK gastro-pubs, which comprises 191 premises, all offering the same food menu. The fourteen sites were selected owing to their ‘typical’ range of appliances (common and similar appliances used across the chain of businesses and the gastro-pub sector in general). Common food

items cooked from the menu include burgers, pies, sausages, hot sandwiches and casseroles. The equipment contained within the study kitchens is surprisingly varied, given that they are part of a large chain. While there is a general template set-up for the pubs (laid down by the central office), the layouts, makes, models and capacities and number of the appliances differ substantially between the sites.

2.2 Monitoring of electricity consumption

Electricity supply was monitored using a system produced by a company—NoWatt Limited (Guildford, UK). The system consists of many purpose-built transformers that were fitted to breakers in the distribution boards of the incoming electricity supplies (Figure 1). Included in this were sensors. The sensors take sub-cycle readings at a rate of 12 800 times a second, enabling the differentiation of devices on a single circuit breaker by an advanced disaggregating software.

The sensors are connected to concentrators which send the high resolution readings (in real-time) to a signal gateway which then transmits the information to a central database via a Global System for Mobile Communications (GSM) network (3G). The raw data were stored in a standard SQL database (MySQL). There is no local display (or other features) on the sensors/concentrator; all information is retrieved from the central database (over the Internet). The advantages of such a system are that no additional wiring is required to commence monitoring, the system is relatively visually and practically unobtrusive and the data can be accessed in real-time in virtually unlimited resolution.

To ensure that this study was not subject to the Hawthorne effect (i.e. people who are aware they are being observed tend to alter their behaviour [12]), kitchen operating staff were not informed of the monitoring.

2.3 Data analysis

Whole building electricity and gas consumption was monitored for one year at one site to represent a case study of the gastro-pubs

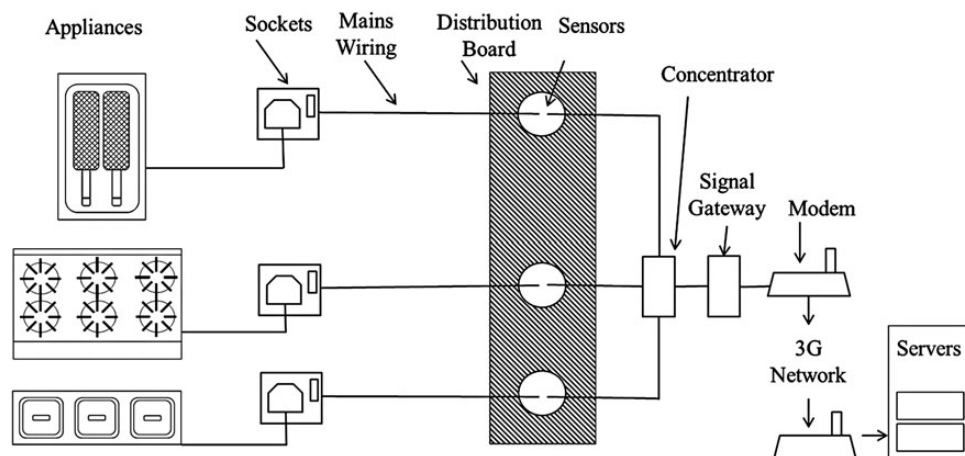

Figure 1. Diagram of appliance monitoring system.

Table 1. Summary of business (physical) area.

Area	Description
Kitchen	Air handling, lighting, cooking equipment, refrigeration, hot storage, warewashing.
Restaurant	Air handling, lighting, sundry sockets (vacuum, etc.), gas central heating, hot water.
Cellar	Air handling, beverage cooling, beverage pumps.
Bar	Glass washing, lighting, bottle fridges, ice machine, coffee machine.

Table 2. Summary of end functions.

Area	Description
Warewashing	Dish and glass washers.
Freezers and fridges	All walk-in, stand alone and under counter refrigeration and freezing units, ice machines and cellar beverage chillers.
Cooking	All appliances utilised to prepare meals and store hot food, coffee machine.
Lighting	All external and internal lighting.
Air handling and hot water	All air handling including ventilation, gas central heating, air conditioning (restaurant and bar), cellar cooling.
Other	Sundry sockets used ad hoc (vacuum, etc.), building alarms, hand driers, beverage pump, office computer.

annual energy usage. This takes account of seasonal patterns of appliance use (such as heating and air conditioning) and consumer behaviour (such as increased ‘eating out’ in the holiday seasons). This information was analysed by business area and then by appliance end-use as described in Tables 1 and 2. Energy utilised in the boiler, providing gas central heating and hot water in the premises could not be separated by end function and has been included within the restaurant in Table 1 (as the majority of radiators are located here), and air handling in Table 2. The premises hot water is only used in cleaning operations and in the toilet facilities; generally hot water from the taps is not used for cooking operations and warewashing appliances are cold fill.

In all subsequent analysis, electricity use data have been gathered exclusively from all cooking and food storage appliances, omitting any kitchen ventilation, warewashing or gas consuming appliances. In these kitchens, gas is only consumed by a large chargrill (charbroiler) and a gas fired oven, usually with six hobs/burners.

For daily analysis of the kitchens’ electricity use, data were analysed from the fourteen monitored kitchens over the period of one week (10 November to 16 November 2012) as this represents the consumer cycle (more meals are generally served on Saturdays and Sundays). This is then averaged to form average daily usage. It must be recognised that data pertaining to the week of study may be subject to seasonal and occupancy variations, e.g. school holidays, unusual weather events, etc. However, the period of study represents a ‘typical’ weekly consumer cycle that does not fall during a holiday season.

To identify patterns of catering appliance usage, consumption was attributed to broad categories of an appliance, e.g. ‘Fridge’

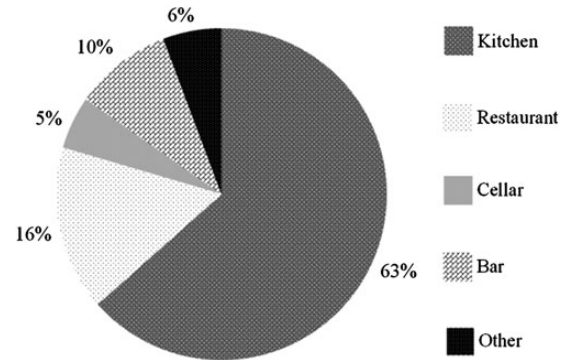
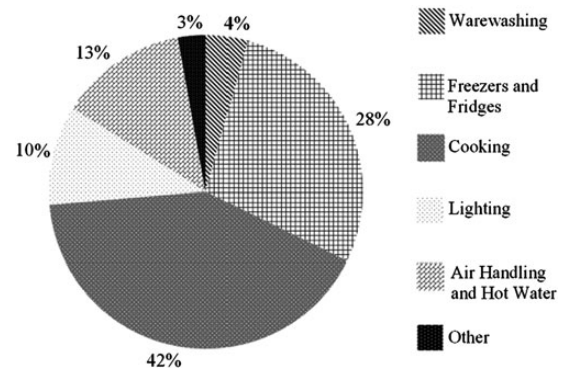
**Figure 2.** Monitored energy consumption by business (physical) area.**Figure 3.** Monitored energy consumption by end function.

or ‘Fryer’. Even within the same chain of businesses, the kitchens contain different numbers, makes and models of appliances each with varying capacities, conditions and locations within the kitchens. It is particularly challenging to compare ‘like for like’ appliances. Additionally, the kitchens vary in the number of meals cooked. Therefore, the total electricity use of each kitchen, as well as the total consumption of each appliance category has been taken and averaged per day for each day of the study week to indicate the average daily total electricity use, which should be treated with caution.

Data for each site and appliance were analysed with Excel spreadsheets, to calculate the key values of consumption.

3 RESULTS

3.1 Whole building energy use

Figures 2 and 3 display the annual profile of energy use (% kWh) for the case study site (including gas). The results should be considered with caution owing to the singular sample case study and the different relative efficiencies between gas and electricity use. Considering the business areas, Figure 2 clearly demonstrates that the kitchen is by far the largest user of energy. In terms of end function, the cooking of food followed by the storage of food represents the largest energy-using activities; almost 75% of the buildings annual use (Figure 3).

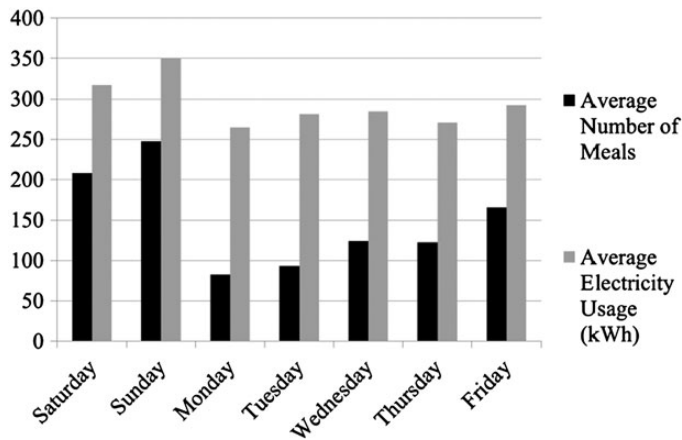

Figure 4. Kitchen monitored electricity consumption (kwh) and number of meals served.

Annual consumption figures by area and function differ significantly from the previous estimates in published literature (23 and 6% used for cooking and refrigerated food storage, respectively) [4, 5]. The consumption in the case study site represented a total expenditure of £37 872 (582 694 kWh); the second largest expenditure to the business after labour costs.

Floor area data were unavailable to normalise the energy use in kWh/m². Floor area data are often difficult to obtain within the licenced restaurant and public house sector owing to frequent evaluation by the UK Valuations Office Agency for the purposes of tax rates [3].

3.2 Total kitchen electricity consumption

The average daily electricity consumption for the 14 kitchens is illustrated in Figure 4 together with the average number of meals served. This clearly demonstrates that consumption is only marginally affected by trade volume. As expected, there is increased consumption over the weekend. However, given a 152% reduction in meal output on a Monday compared with a Saturday (Figure 4), consumption only decreases by 20%. This is largely due to operator behaviour. Between the sites, there was significant variation in the kWh per meal 'efficiency ratio'; 1.52 kWh/meal per week efficiency at Kitchen 3 (the most efficient kitchen), compared with 3.32 kWh/meal per week at Kitchen 7, the least efficient kitchen.

The 24-h profile of kitchen electricity usage has been averaged across all days of measurement and all kitchens (Figure 5). This demonstrates that the kitchens rarely reduce the consumption of appliances during the mid-afternoon lull in cooking volume but should be interpreted with caution owing to the small sample size and for the reasons discussed previously. The average daily usage for the sites was 294.4 kWh. Figure 5 also indicates that average base load consumption (between 00:00 and 05:00) is 9% of the total load; the majority of this is refrigeration. The average base load of 00:00–05:00 was selected owing to the variation in times of early morning activities between and within the sample kitchens (cleaning to start between 05:00 and

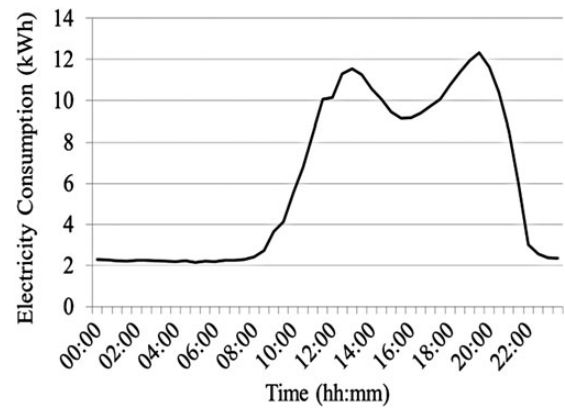

Figure 5. Kitchen average monitored 24-h electricity consumption.

06:30, etc.) Figures 6 and 7 allocate the kitchens' electricity use into the main broad appliance categories. The variation in appliance electricity use between kitchens can be viewed in more detail in Figure 6 and Table 3. Figure 7 averages the data across all days of measurement and all kitchens. The total average refrigerated storage electricity usage is ~41% of the kitchen total, with the remaining 59% attributed to cooking appliances.

3.3 Key appliances

3.3.1 Refrigeration

Other refrigeration additional to the walk-in units represents the largest category of electricity use in each of the study kitchens. In addition to one large walk-in fridge and walk-in freezer unit at each site, the average number of additional refrigerating appliances was nine units: six fridges and three freezers per site (average of 7.7 kWh per stand-alone storage device).

Overall, the conditions of the refrigerating appliances were poor. Ad hoc observations indicated that ~50% of the units (including walk-ins) had some kind of fault or developing problem.

While all other appliances in the study group remained in their respective states of repair throughout the monitoring period, maintenance was conducted on the Walk-in Freezer at Kitchen 12 during the week of study. Comparing the pre-maintenance daily consumption (Figure 8) with the post-maintenance usage (Figure 9), this represented a 45% electricity reduction. A common fault observed was that over 50% of units displayed incorrect temperatures; the digitally displayed temperature is not always the actual monitored temperature of the refrigerator, and this will correspond to electricity wastage (and has implications for food safety). Appropriate maintenance is vital to energy reduction in these premises. However, a barrier to the implementation of planned, preventative maintenance (PPM) contracts in multi-site operators such as the study kitchens is their prohibitive cost. Yearly PPM servicing is likely to yield substantial overall savings in its first year as equipment is brought to a suitable condition. However, the further benefit in future years is reduced compared with the yearly cost of maintenance contracts. Performing maintenance 'in house' within the kitchen operators

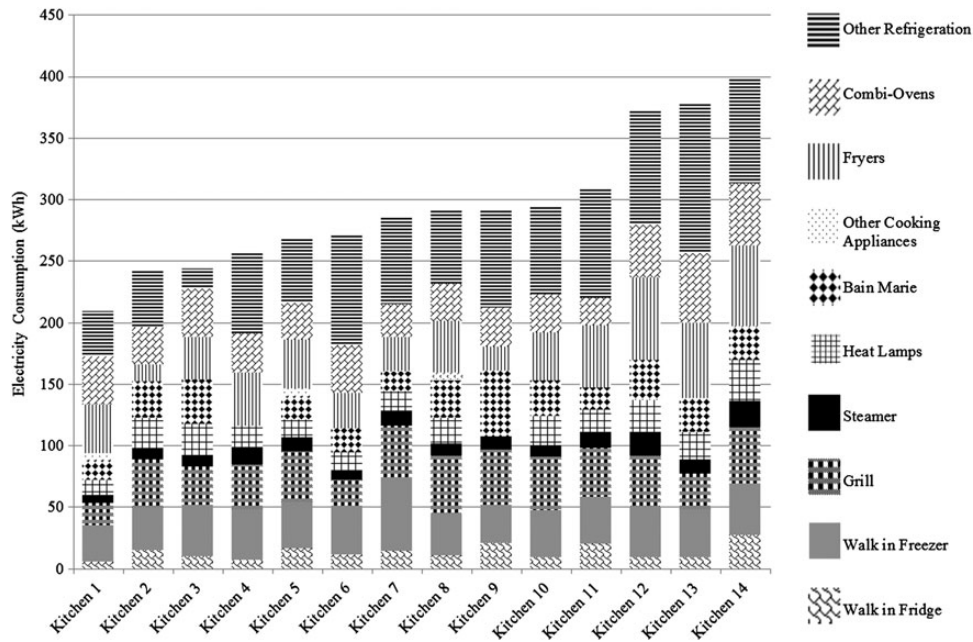

Figure 6. Average monitored kitchen consumption composition (kwh).

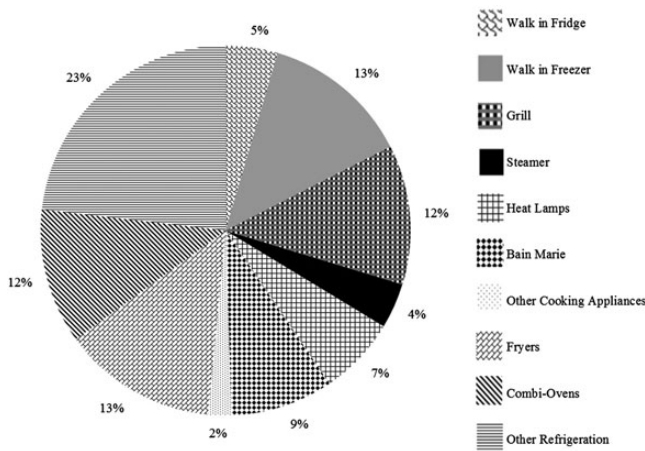

Figure 7. Average monitored kitchen consumption composition (%).

may be cheaper; however, it will require substantial initial training and increased payrolls for the operator. This would need to be balanced against potential electricity savings.

The layouts of the kitchens did not lend themselves to energy conservation regarding refrigeration. Refrigerating appliances in close proximity to a heat source (grill, etc.) were noted to have raised consumptions by ~30% in some instances. However, the causality of this relationship cannot be determined in this study owing to the highly variable makes, models, ages and conditions of the appliances. When questioned regarding the motivations for the locations of fridges in close proximity to heat sources, kitchen operators were far more concerned with the kitchen layout with regards to the physical work flow requirements of chefs during cooking, for example, all appliances required for

dessert production in one area, all appliances for preparation of meats in another area, regardless of the potential cost savings in placing refrigeration away from grills and ovens, etc.

An increased frequency of deliveries, lowering food storage capacity requirements, is a consideration for energy reduction, although this would require complex analysis of the food and waste volumes, sizes of minimum deliveries and the cost of frequent of deliveries. It is doubtful that full consolidation into a single larger walk-in appliance would be acceptable owing to the need for other appliances as contingency in case of appliance failure.

3.3.2 Grills

Grills contribute a relatively constant load to the kitchens' electricity use (12%). The grill is significantly influenced by operator behaviour. Figure 10 compares two grills of the same make and model on the same day from two kitchens. The grill in Kitchen 10 suffered from poor, (but typical) operator behaviour. The appliance was switched to maximum where it remained until the end of service; it used 49 kWh. The grill in Kitchen 6 was managed much more appropriately from an energy conservation perspective; the temperature was reduced when not in operation. This grill consumed 14 kWh; 71% saving compared with the typical operation owing to appropriate behavioural management alone. Interestingly, Kitchen 6 consistently served more meals at lower electricity usage when compared with Kitchen 10. The only considerable difference was with respect to the operators' behaviour and attitude towards using the appliance.

It was observed during the study that the grill was often used merely to brown items for a few minutes (such as sausages or cheese toppings) after oven cooking. Options for reducing

Table 3. Relevant statistics of the average consumption of catering appliance categories, carbon emissions and cost.

Appliance category	Average number of appliances per kitchen	Average total daily (kWh)	Relative standard deviation of total kWh per day (%)	Average daily carbon (kg CO ₂) (calculated from [13])	Average daily cost (£)
Walk-in fridge	1	13.81	45.89	7.14	1.52
Walk-in freezer	1	39.17	23.25	20.25	4.31
Grill	1	36.89	27.89	19.07	4.06
Steamer	1	11.99	47.35	6.20	1.32
Heat lamps	15	20.70	35.42	10.70	2.28
Bain marie	1	27.19	44.49	14.06	2.99
Other cooking appliances	3	6.08	37.35	3.14	0.67
Fryers	3	40.82	43.54	21.11	4.49
Combi-ovens	3	35.71	34.16	18.46	3.93
Other Refrigeration	6 Fridges, 3 Freezers	70.13	38.86	36.26	7.71
Total kitchen	29	294.37	22.99	152.19	32.38

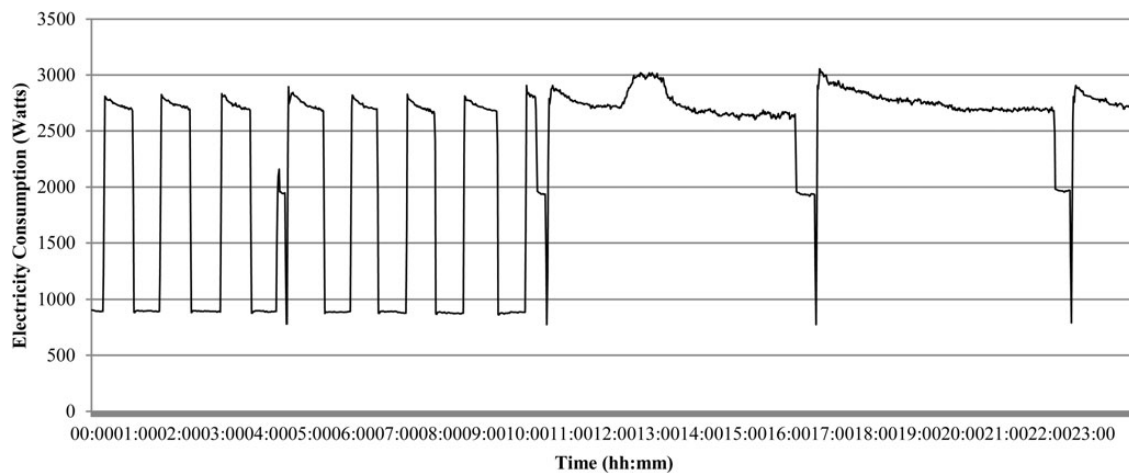
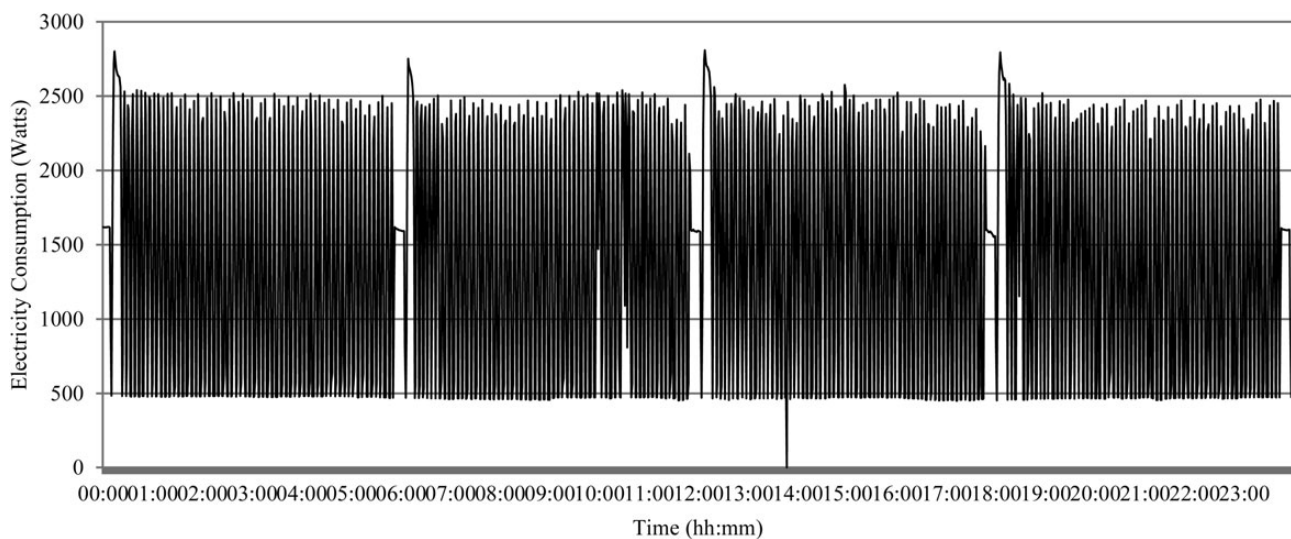
**Figure 8.** Walk-in freezer monitored electricity consumption (Watts) at Kitchen 12 on 10th November (pre-maintenance).**Figure 9.** Walk-in freezer monitored electricity consumption (Watts) at Kitchen 12 on 16th November (post-maintenance).

energy use include extending the oven-cooking time or programme to include browning. The warm-up time of ~20 min may be an obstacle to turning it down or off when not in use.

3.3.3 Hot-holding appliances

Bain maries (hot air or water containing appliances over which food items are placed) and heat lamps (situated above or below

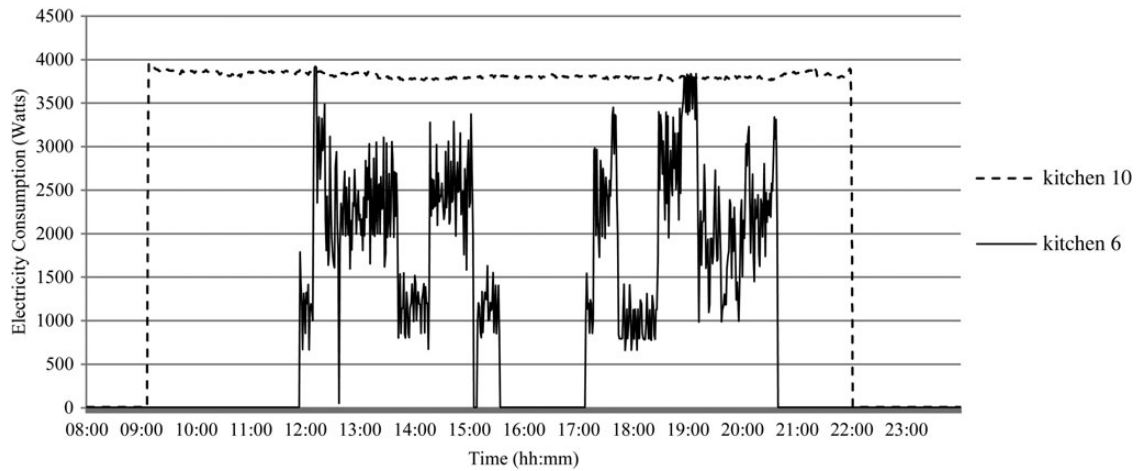

Figure 10. Grill monitored electricity consumption (Watts) at Kitchens 10 and 6.

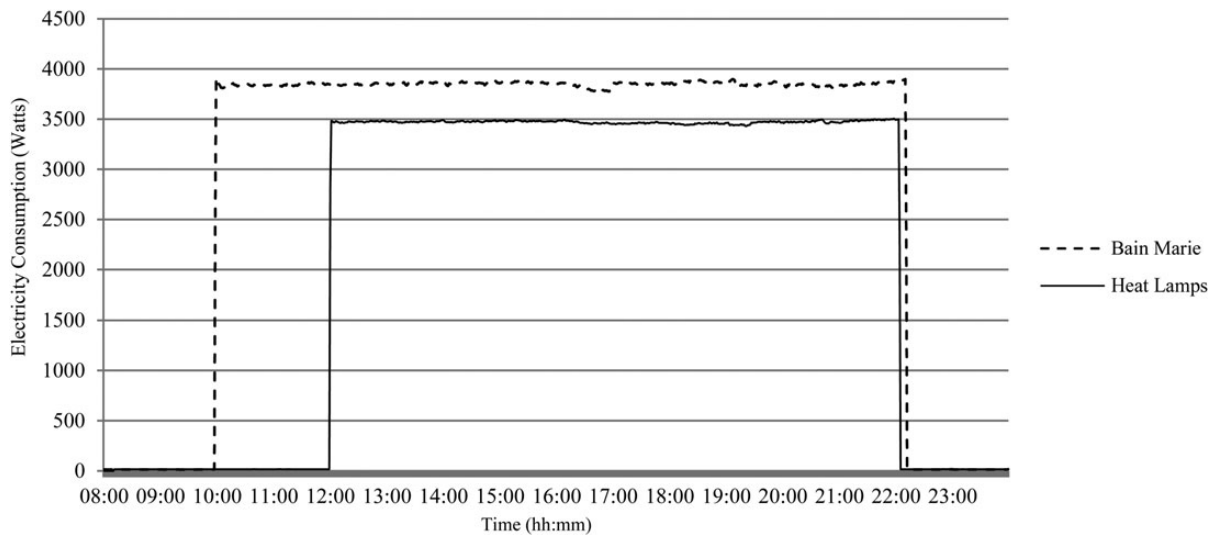

Figure 11. Typical hot-holding daily monitored electricity consumption (Watts) (from Kitchen 13).

gantries) are regularly employed in commercial kitchens to maintain food at the desired temperature while further food items are waiting to be served. Both bain maries and heat lamps are able to be switched off during low periods of service (~15:00–17:00). However, typical consumption profiles of heat lamps and bain maries indicate that this option is not often utilised by staff (Figure 11). The consumption dataset from Kitchen 13 has been specified (Saturday, 10 November) as this represented the median hot-holding consumption from all kitchens and all days. Interestingly, research suggests that the practice of hot-holding reduces the nutrient content and palatability of the items [9]. In the sample kitchens, bain maries were only found to be used to keep sauces at serving temperatures and were correspondingly oversized for this function. Sometimes plates were held at high temperature within the cabinet. Hot-holding appeared to be an extremely wasteful and potentially unnecessary activity; with better management of the

cooking operations, elimination of hot-holding may save an average of 48 kWh/day per kitchen (16%).

Fitting simple and inexpensive time clocks or motion sensors to heat-lamp gantries would yield substantial savings with relatively short payback times. Interestingly, one of the few existing previous academic studies pertaining to more effective operating behaviours suggests the very same removal or adjustment of hot-holding appliances [14]. Yet, in almost three decades since the majority of previous studies in this area, and with much increased focus on energy savings in the UK in recent years, these modest investments are not being made.

3.3.4 Further observations

The vast majority of appliances monitored had the option to be thermostatically controlled with varying levels of heat set by the operator, but this was poorly utilised. Only the electricity use profiles of microwaves and to some extent fryers and

combination ovens were found to relate to usage/food output; consumption increased during cooking and automatically decreases after the pre-programmed cooking times. The appliances are not usually insulated; manufacturers claim this is due to associated fire risk [15]. One clear approach to energy reduction is through better product design; this has been the focus of recent UK and EU policy via the Eco-design of Energy using Products Directive (2005/32/EC), which was altered and expanded in 2011 (Eco-design of Energy-related Products Directive—2009/125/EC). It has recently been enlarged to include domestic and commercial grills and hobs [16] but requires further development.

All kitchen staff in the study kitchens received some basic training regarding energy reduction upon joining the businesses. The managers of each site are aware of the importance of energy management to their monthly profit and loss accounts. However, the example of the energy-thrift behaviour in grill usage at Kitchen 6 was the only well-managed appliance during the entire week of study. An acceptance of the need for energy conservation exists, but it would appear that poor management of energy use remains unchallenged.

4 CONCLUSIONS

Electricity use is vastly greater than literature estimates suggested with kitchen and food-related activities greatly outweighing other energy-using activities. Consumption is highly variable between kitchens and appliances due in part to the wide variety of makes and models of appliances implemented. The combined averaged consumption of refrigerated storage appliances in each kitchen equated to 41% of the average total electricity use within each kitchen, this represented the largest category of usage. The combined electricity use of hot-holding appliances (heat lamps and bain maries) represented 16%; the third largest electricity users were the grills.

Poor levels of maintenance noticeably contribute to excessive energy use in refrigeration. Generally, correct sizing and consolidation of refrigerated storage will also see energy reduction benefits; this could include more frequent deliveries in an effort to minimise storage capacity.

Current catering appliance design does not lend itself well to energy-thrift behaviour. Appliances are often not insulated and without appropriate controls. Comprehensive life cycle analysis of equipment upon purchase and the procurement of best available technologies in accordance with the Eco-design Directive will undoubtedly yield electricity savings and emissions. However, the study indicated that operator behaviour is a major factor in the excessive use of electricity. A strict 'turn-on, turn-down, turn-off' schedule and better equipment with more appropriate controls could be provided, but it is likely that in the busy working environment, these may be ignored given that the controls that were available in this study were not implemented appropriately by the operator. Turning appliances down/off when not required would save significant amounts of energy, carbon

and cost; however, individuals use equipment in a manner that avoids excessive stress originating from the designs of equipment (long warm-up times or long *perceived* warm-up times), busy schedules, or the overly complex procedures (from an energy reduction perspective) utilised to cook the food laid down by the management. More research is required in the area of behaviour change, addressing the values and motivations of staff and overcoming potential barriers to energy reduction in these environments. A full analysis of the menu offer, kitchen ergonomics and layout, food sales and corresponding equipment capacities is required to assess the practical requirements of the operations, with a view to reducing the kitchens energy usage.

There is much potential for further research into the choice of cooking method and corresponding appliances to reduce overall energy use in the kitchen. Many different methods of cooking the same item were observed during this study. For example, choosing to modify combi-oven cooking to include browning (thereby reducing the need for grilling) could yield savings from the total kitchen electricity use, as the grill was found to be particularly wasteful). The prescribed cooking methods, recipes and procedures could be adjusted to eliminate unnecessary appliances from an energy-thrift perspective, and it is likely that such improvements may also lead to a more comfortable working environment. Better management of these choices should initially focus on reducing the need for hot-holding. These behavioural and management issues must be addressed as a necessity. It is likely it will require greater expense and time for more efficient appliances to be adopted, considering their large capital cost and operational lifespan, compared with the investment in training and better management instructions and practices.

Catering colleges and *in-situ* training may play an important role in engendering energy efficient behaviour amongst the chefs and cooks of the future. For the educational establishments, this could be marketed as a financial benefit to the employers of their graduates. The results of this study are applicable to catering establishments, regardless of sector and may be of interest to kitchen designers, managers and operators serving the catering and hospitality industry in the public and private sectors.

FUNDING

This work has been supported and funded by the Technologies for Sustainable Built Environments (TSBE) centre, Reading University, in conjunction with the Engineering and Physical Sciences Research Council (EPSRC) and Mitchell's and Butler's plc.

ACKNOWLEDGEMENTS

In addition to the credited authors, special thanks must be made to NoWatt Ltd, particularly for the assistance of Mr Allister Mannion, without which this study would not have been possible.

REFERENCES

- [1] HM Government Department for Energy and Climate Change (UK). *The Carbon Plan: Delivering our Low Carbon Future*. HM Government (UK), Department for Energy and Climate Change, 2011.
- [2] CIBSE. *Guide F Energy Efficiency in Buildings*. The Chartered Institution of Building Services Engineers (CIBSE) 222 Balham High Road, London SW12 9BS, 2012.
- [3] Mudie S, Essah EA, Grandison A, *et al.* *Benchmarking Energy Use in Licensed Restaurants and Pubs*. Chartered Institute of Building Service Engineering (CIBSE) Technical Symposium 2013. Liverpool John Moores University, UK, 2013.
- [4] Carbon Trust. *Food Preparation and Catering—Increase Carbon Savings without Compromising on Quality—CTV035*. 6th Floor, 5 New Street Square, London EC4A 3BF, 2008.
- [5] CIBSE. *TM50—Energy Efficiency in Commercial Kitchens*. The Chartered Institution of Building Services Engineers (CIBSE) and Catering for a Sustainable Future Group (CSFG). CIBSE, 222 Balham High Road, London SW12 9BS, 2009.
- [6] Carbon Trust. *Industrial Energy Efficiency Accelerator—Overview on the Catering Sector—CTG060*. 6th Floor, 5 New Street Square, London EC4A 3BF, 2011.
- [7] Newborough M. Energy-efficient cooking systems, food-preparation facilities, and human diets. PhD thesis, Cranfield Institute of Technology, 1987.
- [8] Newborough M, Probert SD. Energy-thrift opportunities for operators of ‘public houses’ in the UK. *Appl Energ* 1988;31:31–57.
- [9] Probert SD, Newborough M. Designs, thermal performances and other factors concerning cooking equipment and associated facilities. *Appl Energ* 1985;21:81–222.
- [10] The Independent. *Struggling Pubs Target the Restaurant Trade*. The Independent—Martin Hickman, 2010. <http://www.independent.co.uk/news/business/analysis-and-features/struggling-pubs-target-the-restaurant-trade-2052365.html>. (11 April 2013, date last accessed).
- [11] Silverman D. *Interpreting Qualitative Data: A Guide to the Principles of Qualitative Research*. 4th Edn Sage Publications, 2011.
- [12] Wood G, Newborough M. Dynamic energy-consumption indicators for domestic appliances: environment, behaviour and design. *Energ Build* 2003;35:821–41.
- [13] BSRIA. Rules of Thumb. BSRIA Ltd. Old Bracknell Lane, West Bracknell, Berkshire, RG12 7AH, UK, 2011.
- [14] Batty W, Conway MA, Newborough M, *et al.* Effects of operative behaviours and management planning on energy consumptions in kitchens. *Appl Energ* 1988;3:205–20.
- [15] FSTC. Commercial cooking appliance technology assessment. Report #5011.02.26. Food Service Technology Center (FSTC). Fisher-Nickle, inc. 12949 Alcosta Boulevard, Suite 101, San Ramon, CA 94583, 2002.
- [16] European Commission. Preparatory studies for eco-design requirements of EuPs (III) Lot 23—domestic and commercial hobs and grills, included when incorporated in cookers. Task 1. European Commission. Paris, France, European Commission in associated with ERA Technology and the Bio Intelligence Service, 2011.